

ZIPPER

A STEVE ANDRE DESIGN

THIS DESIGN CONFORMS TO THE
AMYA CLASS ONE METER
SPECIFICATIONS

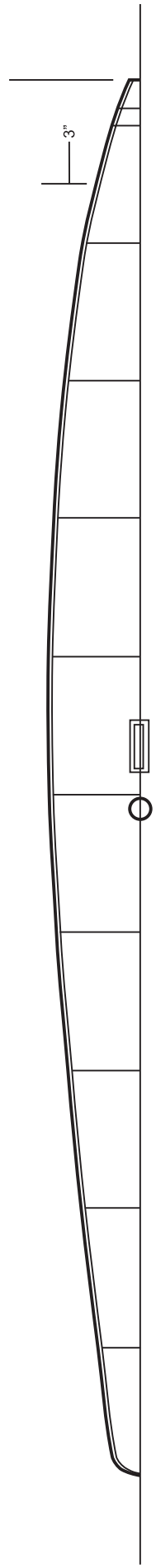

JIBSAIL AREA = 306
51" LEECH x 12" FOOT
(52.392 LUFF x 11.681 LP)

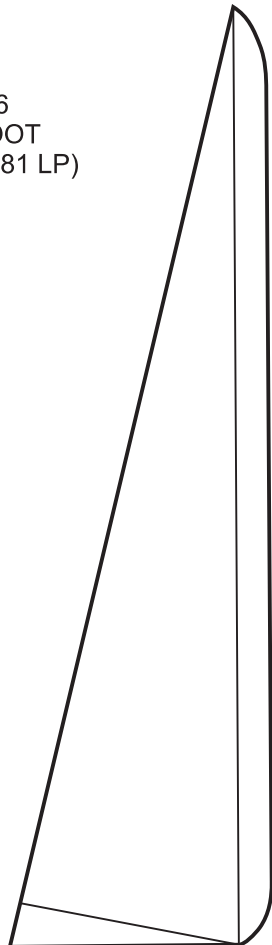

MAILSAIL AREA = 291.5
53" LUFF x 11" FOOT

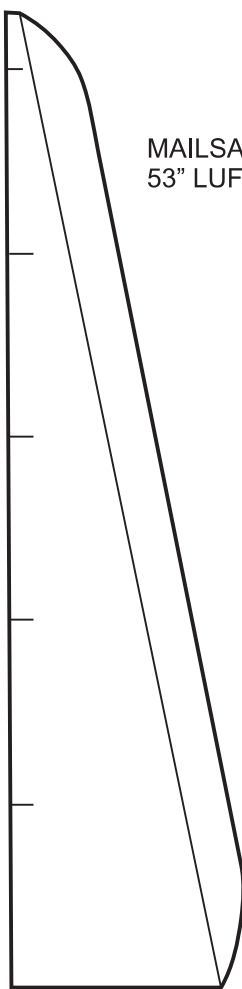

ZIPPER

A STEVE ANDRE DESIGN

THIS DESIGN CONFORMS TO THE
AMYA CLASS ONE METER
SPECIFICATIONS

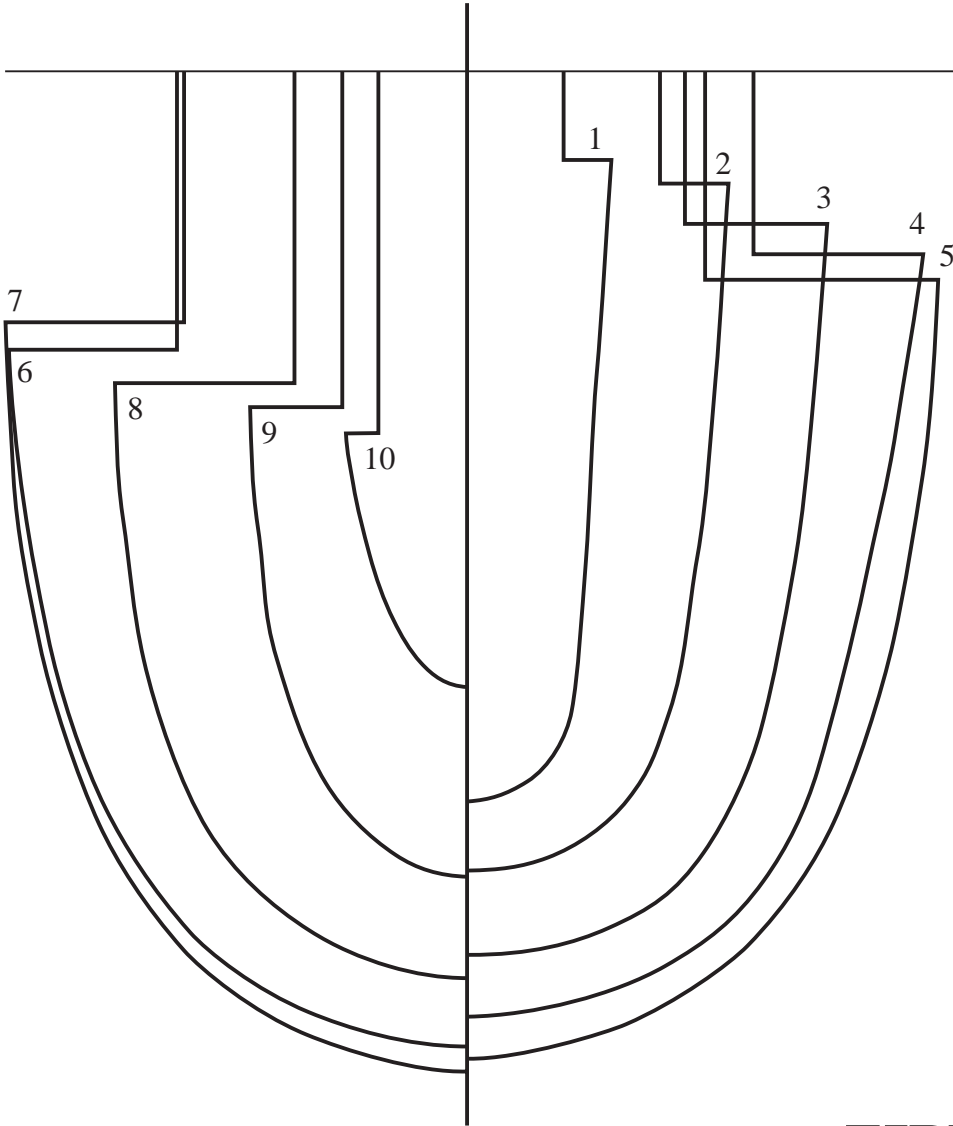

ZIPPER
A Steve Andre Design

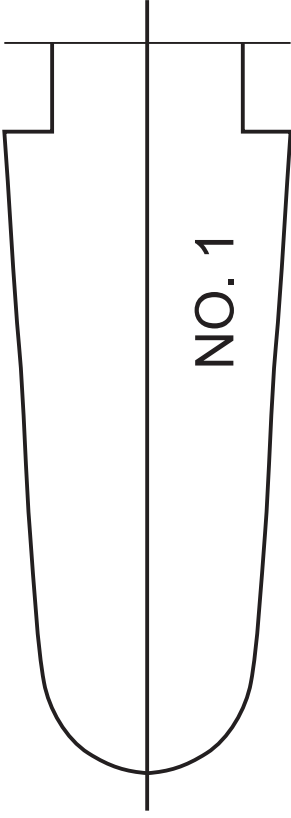
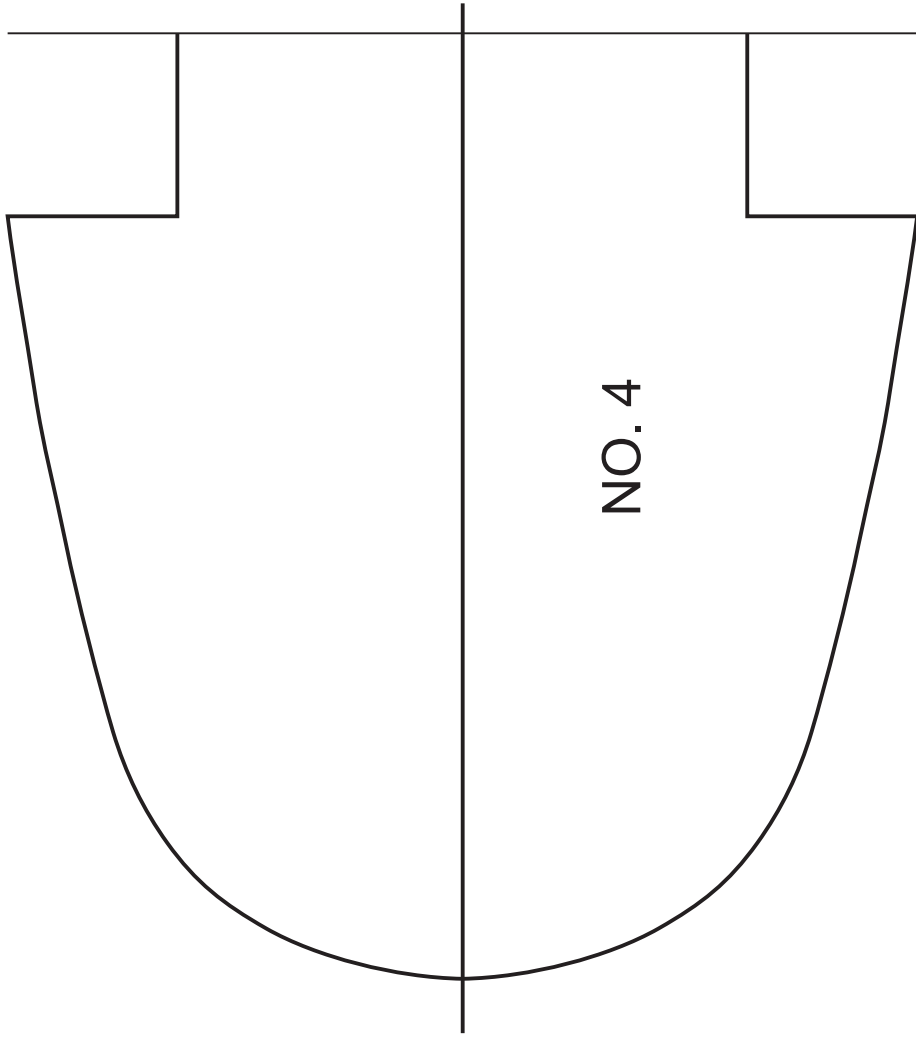

ZIPPER

A STEVE ANDRE DESIGN

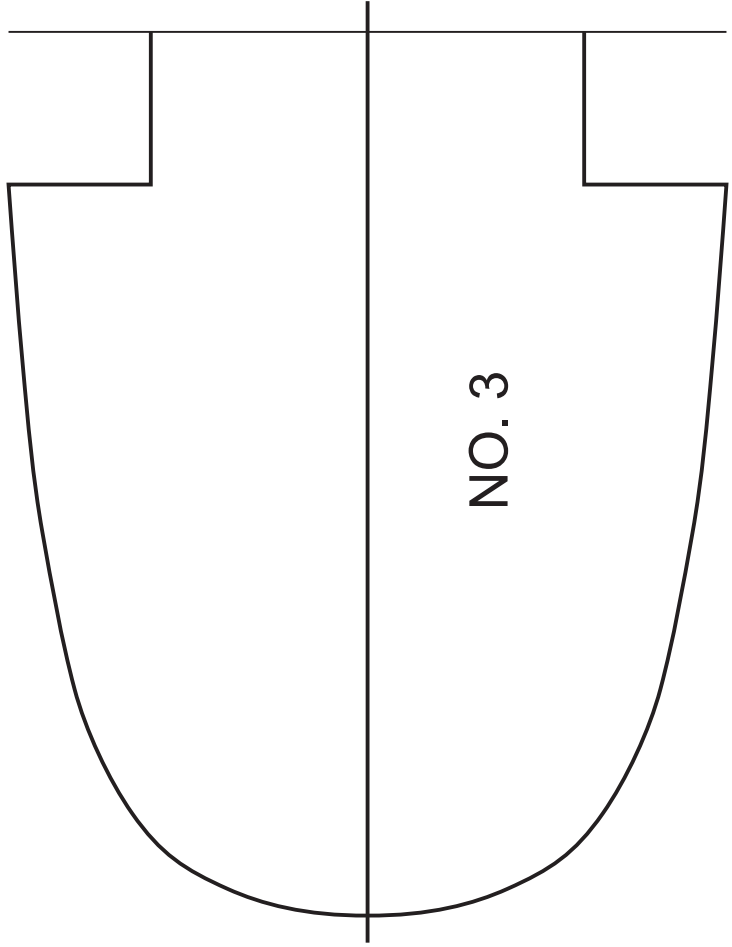
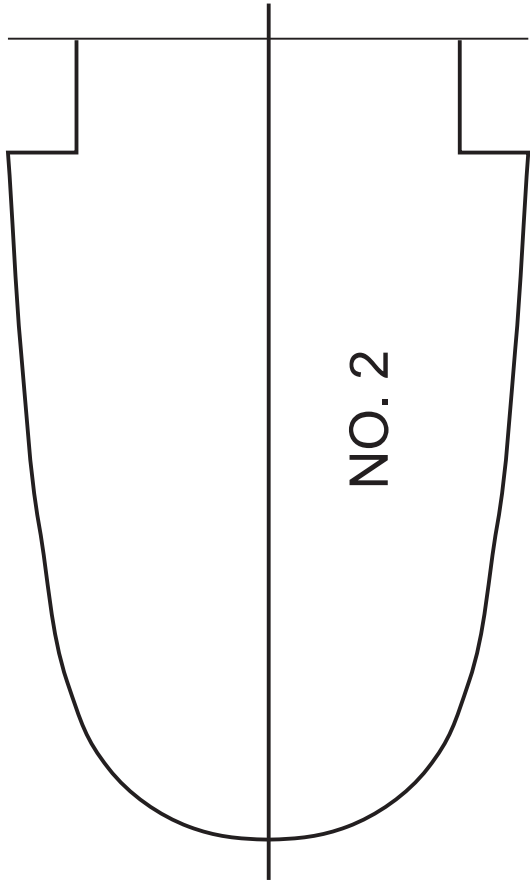

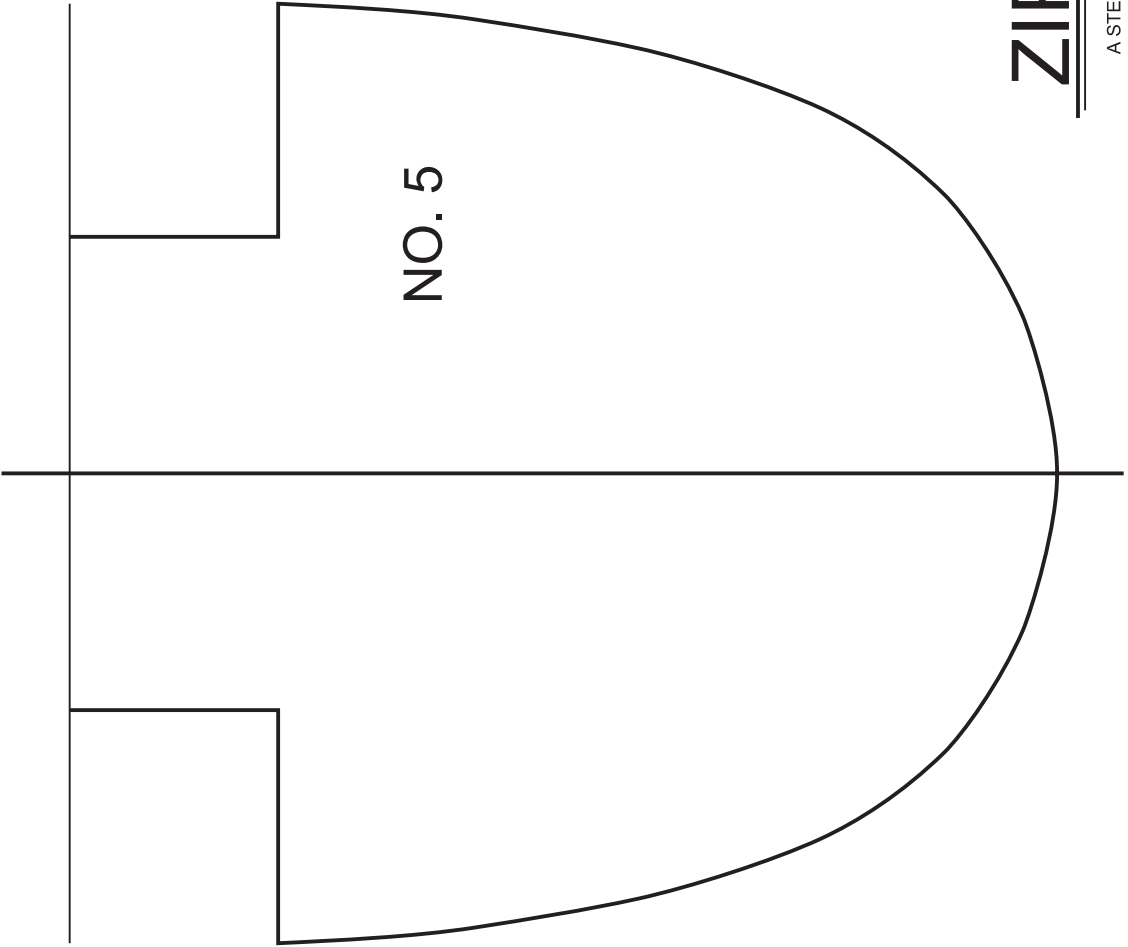

NO. 5

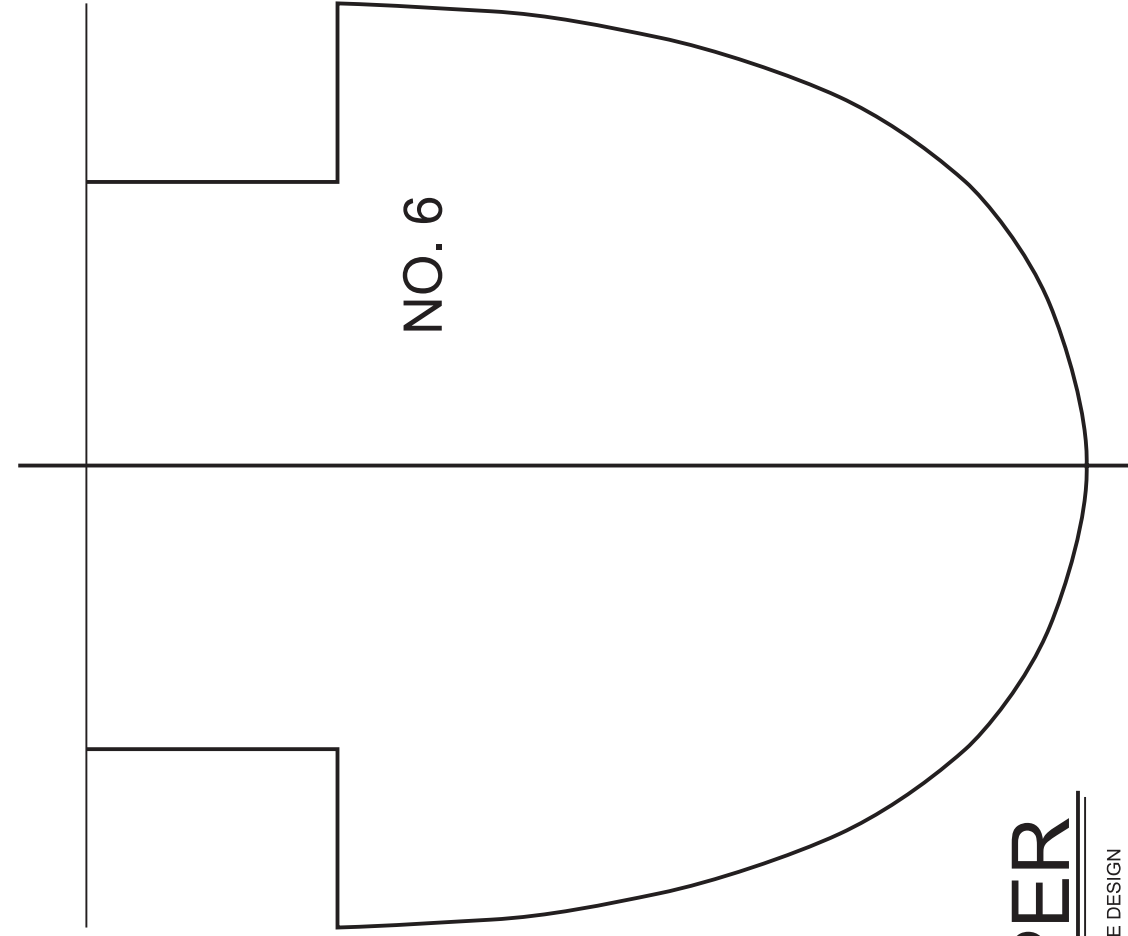

NO. 6

ZIPPER

A STEVE ANDRE DESIGN

SHEET 2

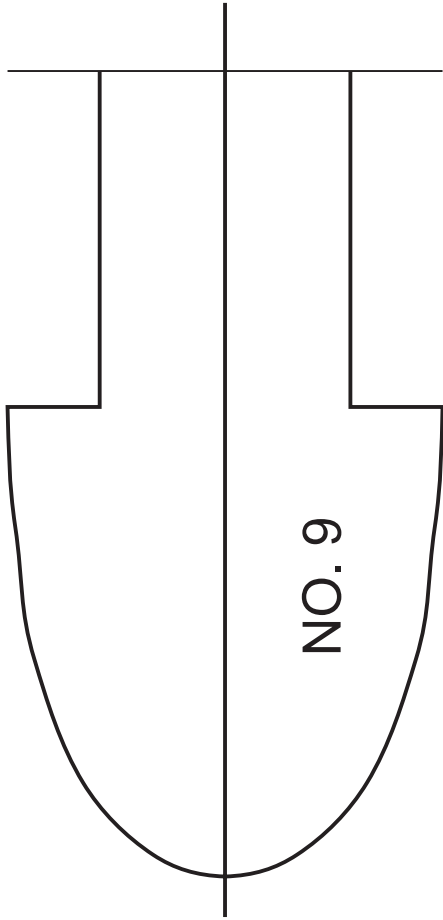
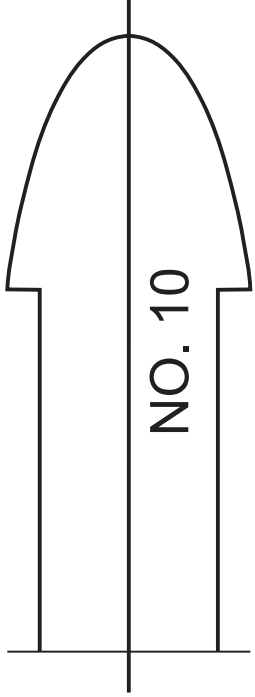

ZIPPER

A STEVE ANDRE DESIGN

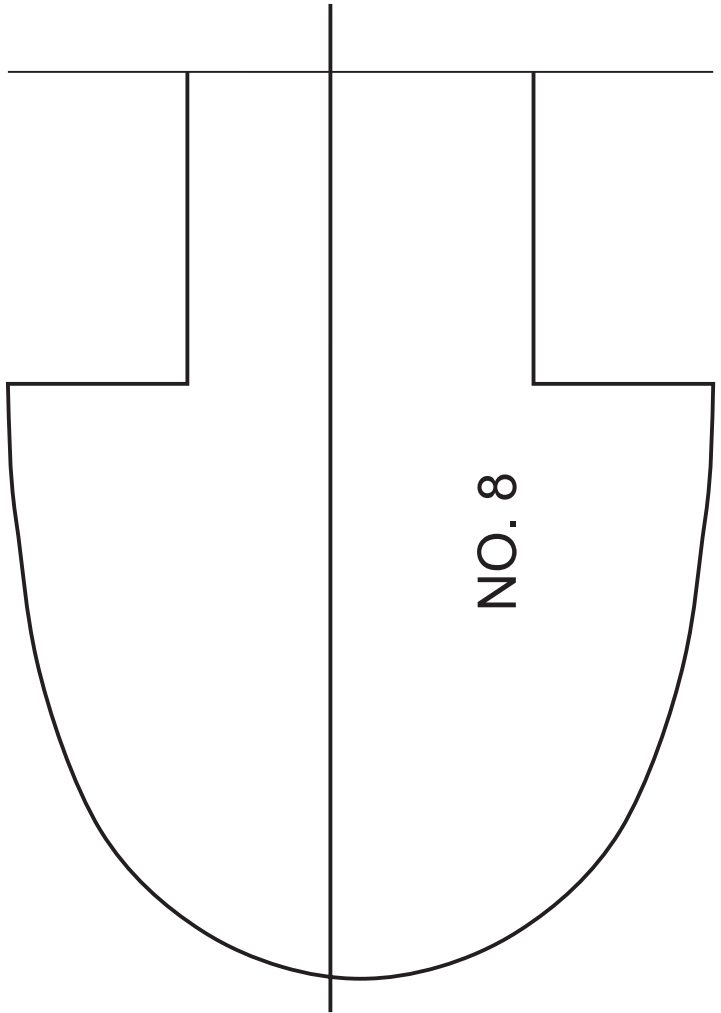
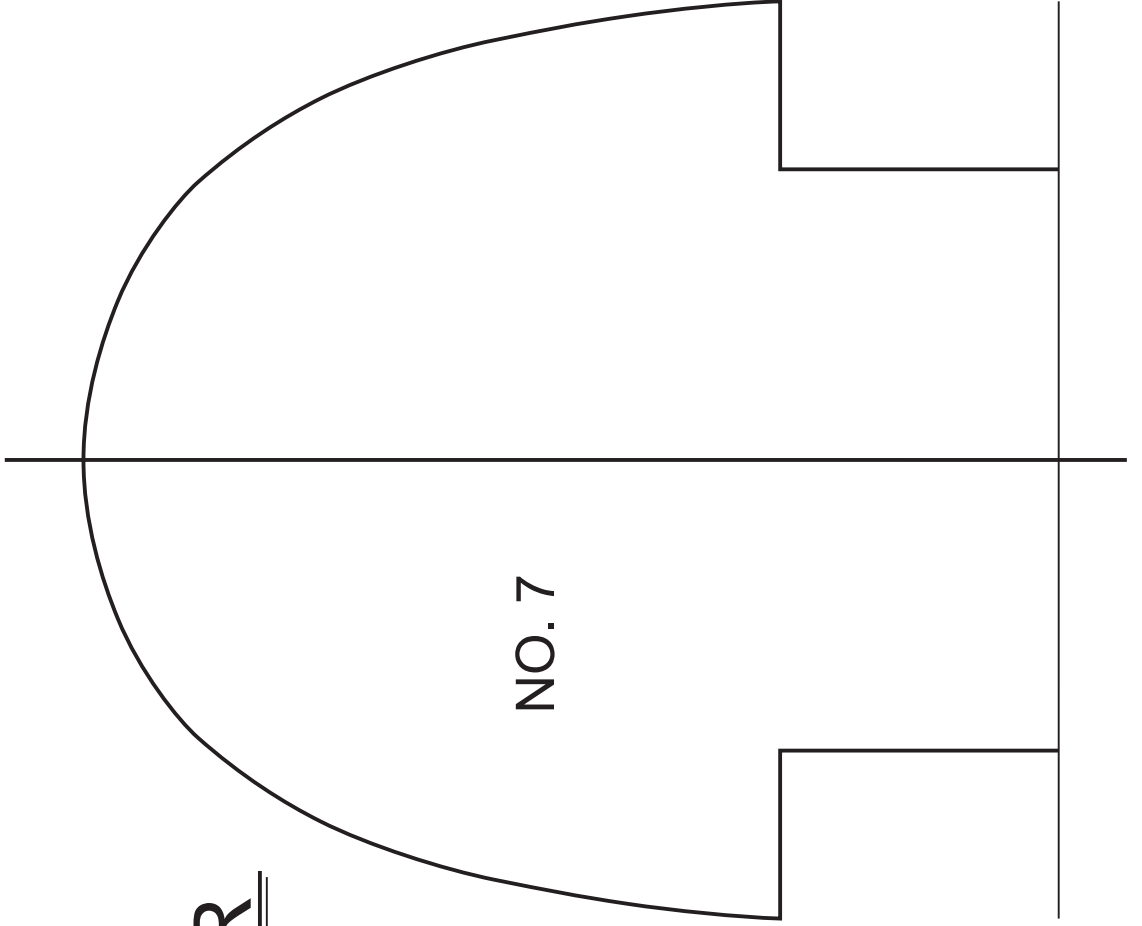

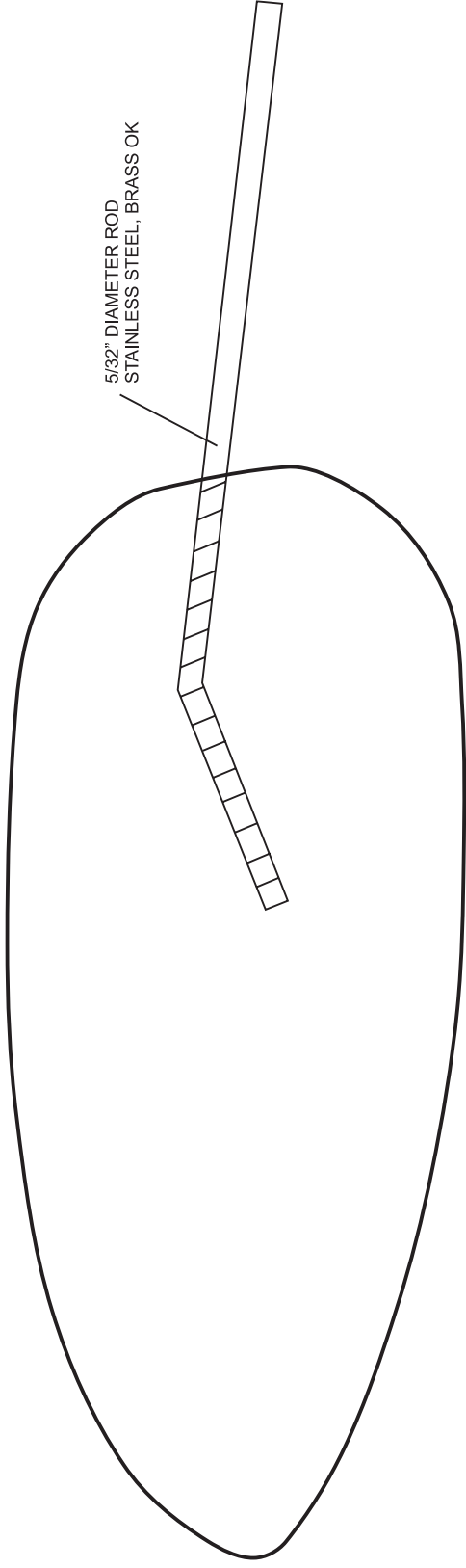

5/32" DIAMETER ROD
STAINLESS STEEL, BRASS OK

ACTUAL SIZE

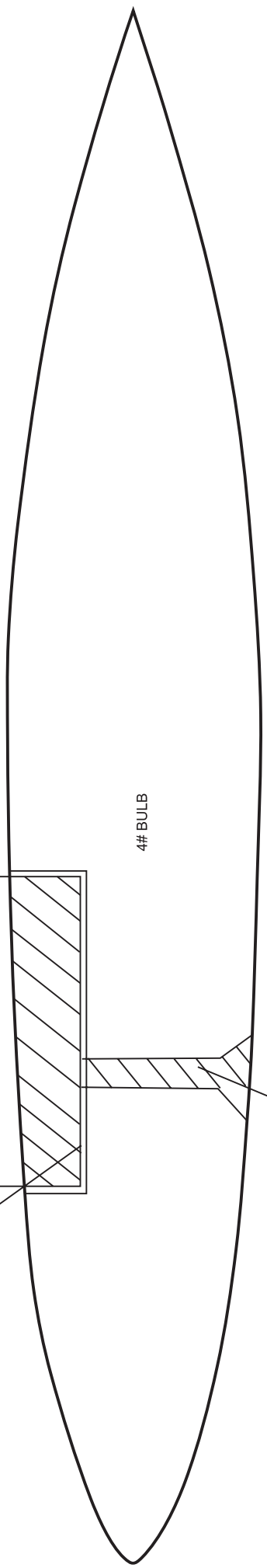

COUNTERSLOT WITH FLAT BOTTOM TO FIT FIN

4# BULB

COUNTERBORE FOR 6-32 STAINLESS STEEL MACHINE SCREW OR
ALL-THREAD WITH NUT AND WASHER FOR HOLDING BULB TO FIN

THIS DESIGN CONFORMS TO THE
AMYA CLASS ONE METER
SPECIFICATIONS

ZIPPER

A STEVE ANDRE DESIGN